

External Communication Box

Manual



Kamstrup A/S
Industrivej 28, Stilling
DK-8660 Skanderborg
TEL: +45 89 93 10 00
FAX: +45 89 93 10 01
E-MAIL: info@kamstrup.com
WEB: www.kamstrup.com

Contents

Introduction	3
Variant Structure	4
Connection	5
Modem Modules	6
M-Bus Module	7
Radio Module	8
LON Module	9
Supply	10

Supply

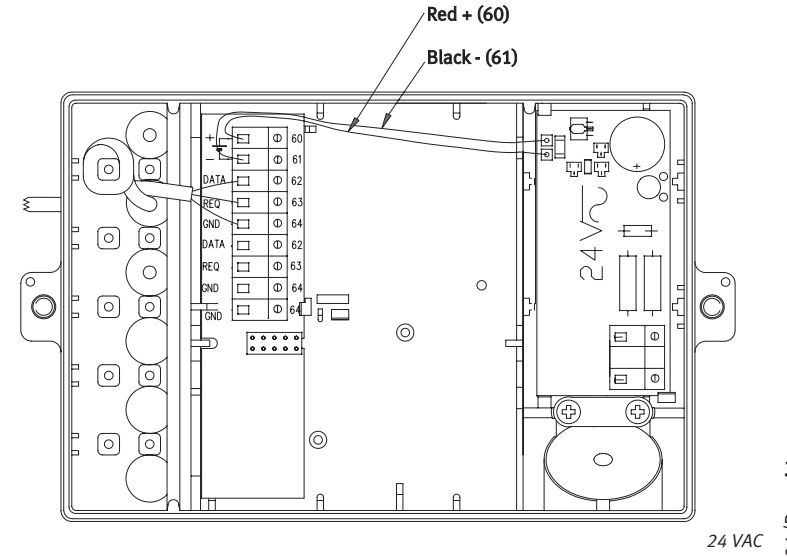

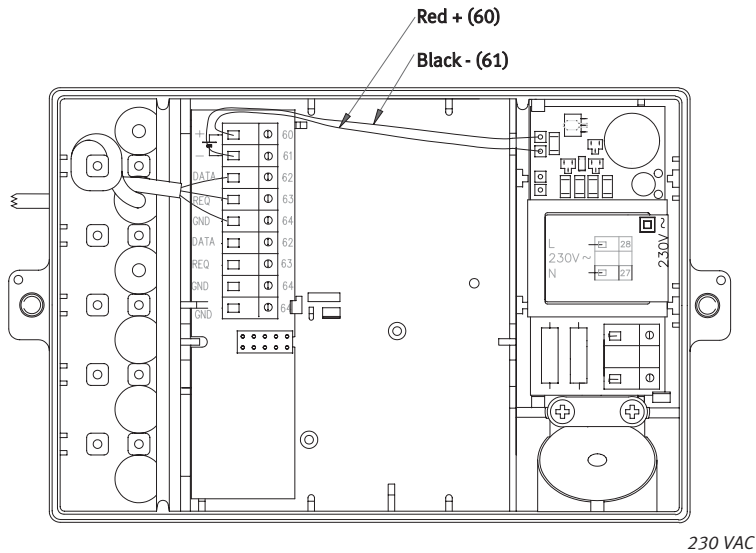
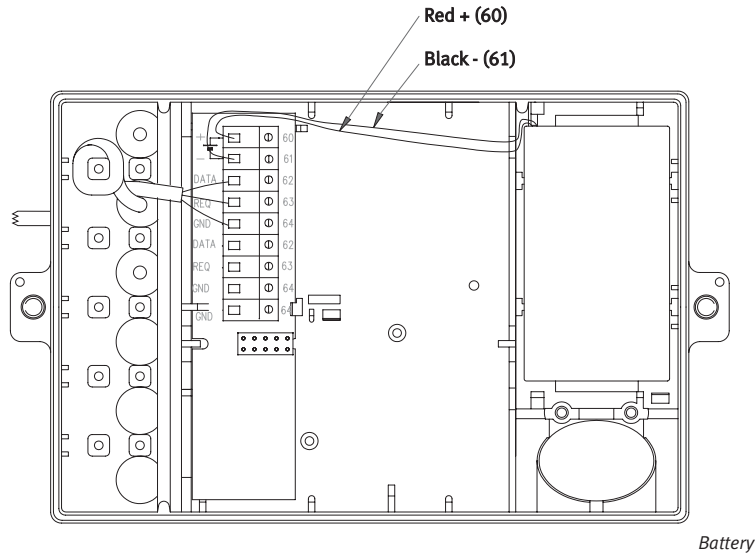

Dansk

Kamstrups eksterne kommunikationsboks benyttes når 2 forskellige fjernaflæsningsformer ønskes fra en MULTICAL® 66-CDE. Da samme MULTICAL® 66-CDE servicerer 2 kommunikationsformer kan der være begrænsninger med hensyn til aflæsningsintervallet. Kontakt venligst Kamstrup A/S for yderligere oplysninger.

English

Kamstrup's external communication box is used when an MULTICAL® 66-CDE requires 2 different remote reading forms. As the same MULTICAL® 66-CDE services 2 forms of communication there might be limitations as regards the reading interval. Please contact Kamstrup A/S for further details.

Deutsch

Der externe Kommunikationseinheit von Kamstrup wird verwendet, wo man von einem MULTICAL® 66-CDE zwei verschiedene Fernablesearten wünscht. Da der MULTICAL® 66-CDE somit zwei Kommunikationsarten arbeitet, kann es in bezug auf Ableseintervall Begrenzungen geben. Nehmen Sie bitte für weitere Auskünfte mit Kamstrup A/S Kontakt.

Svensk

Kamstrups externa kommunikationsbox används när 2 olika typer av fjärravläsning önskas från en MULTICAL® 66-CDE. Då samma MULTICAL® 66-CDE server 2 kommunikationstyper kan det finnas begränsningar beroende på avläsningsintervallet. Kontakta Kamstrup A/S för ytterligare upplysningar.

Variant Structure

Variant structure	66	-	9	-	x	-	x	-	x	-	x	-	x	-	3xx
External Communication Box															
Connection															
Direct, 3-wire															1
Optical															2
Module															
No module															0
Modem - pulse input															3
M-Bus - pulse input (MULTICAL® III)															4
Modem - pulse output															5
M-Bus - pulse output (MULTICAL® III)															7
M-Bus - pulse input															8
M-Bus - pulse output															9
Radio - pulse input															A
Radio - pulse in - external antenna															B
LON															F
Supply															
Battery															2
230 VAC															3
24 VAC															4
Fitting															
No fitting															0
Standard MULTICAL® fitting															1
DIN-rail															2
Instruction															1
Frequency code - used by Kamstrup															3xx

LON Module

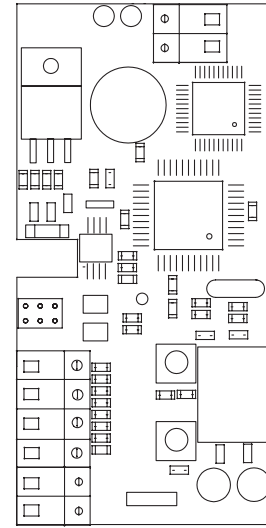

66 0F 000 100

Radio Module

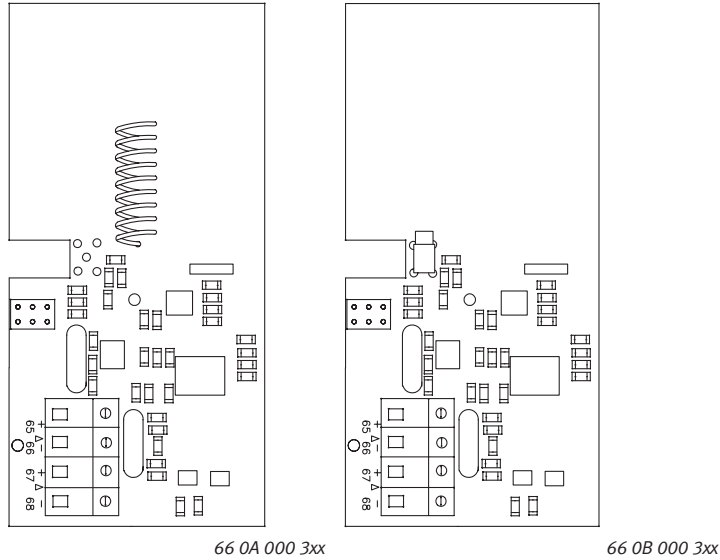

Dansk

Følgende radiovarianter kan benyttes i den eksterne kommunikationsboks:

- 66 0A 000 3xx pulsindgange
- 66 0B 000 3xx pulsindgange, ekstern antenne

English

Following radio variants can be used in the external communication box:

- 66 0A 000 3xx pulse inputs
- 66 0B 000 3xx pulse inputs, external antenna

Deutsch

Folgende Funkvarianten können in der externen Kommunikationseinheit verwendet werden:

- 66 0A 000 3xx Impulseingänge
- 66 0B 000 3xx Impulseingänge, externe Antenne

Svensk

Följande radio varianter kan användas i den externa kommunikationsboxen:

- 66 0A 000 3xx pulsingångar
- 66 0B 000 3xx pulsingångar, externa antenna

Connection

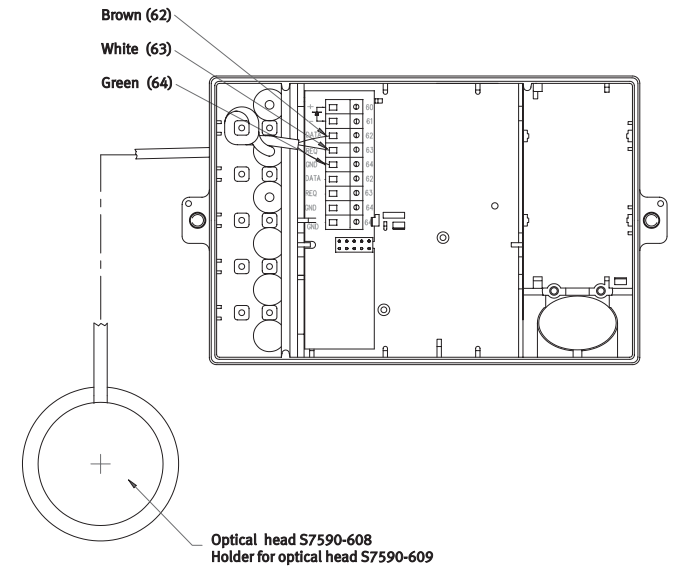
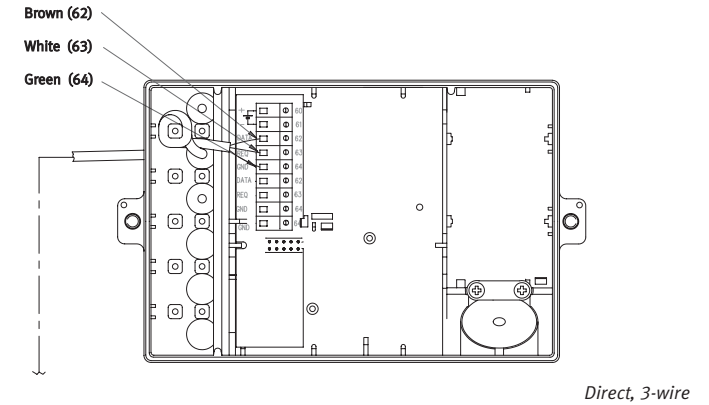

Optical

Modem Modules

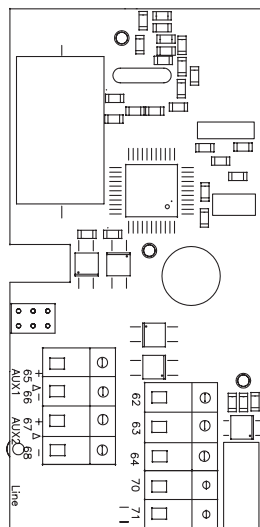

66 03 000 3xx

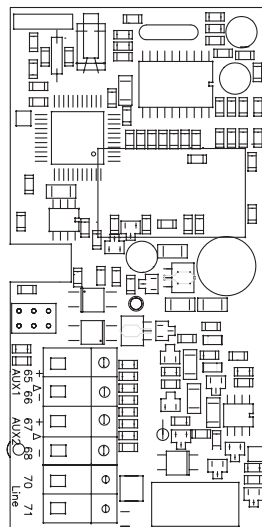

66 05 000 3xx

Dansk

Modem kan kun benyttes ved direkte forbindelse mellem energimålere og eksterne kommunikationsboks - ikke ved optisk forbindelse.

English

Modem can only be used by a direct connection between energy meters and external communication box - not in connection with optical connection.

Deutsch

Modem kann nur bei Direktanschluss zwischen Energiezähler und externem Kommunikationseinheit verwendet werden - nicht bei optischem Anschluss.

Svensk

Modem kan endast användas vid direkt förbindelse mellan energimätare och extern kommunikationsbox - inte vid optisk förbindelse.

M-Bus Module

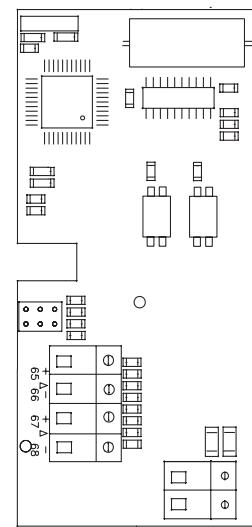

66 04 000 100

Dansk

Følgende M-Bus varianter kan benyttes i den eksterne kommunikationsboks:

- 66 04 000 100 pulsindgang - MULTICAL® III
- 66 07 000 100 pulsudgang - MULTICAL® III
- 66 08 000 100 pulsindgang
- 66 09 000 100 pulsudgang

English

Following M-Bus variants can be used in the external communication box:

- 66 04 000 100 pulse input - MULTICAL® III
- 66 07 000 100 pulse output - MULTICAL® III
- 66 08 000 100 pulse input
- 66 09 000 100 pulse output

Deutsch

Folgende M-Bus Varianten können im externen Kommunikationseinheit verwendet werden:

- 66 04 000 100 Impulseingang - MULTICAL® III
- 66 07 000 100 Impulsausgang - MULTICAL® III
- 66 08 000 100 Impulseingang
- 66 09 000 100 Impulsausgang

Svensk

Följande M-Bus varianter kan användas i den externa kommunikationsboxen:

- 66 04 000 100 pulsingång - MULTICAL® III
- 66 07 000 100 pulsutgång - MULTICAL® III
- 66 08 000 100 pulsingång
- 66 09 000 100 pulsutgång